



ANLY TIMER

H3D-M MULTI-FUNCTION ANALOGUE TIMER



CHARACTERISTICS :

- Wide operating voltage range, AC/DC 12V~240V
- 7 output modes :
On-delay
Control contact OFF-delay
Interval
Trailing edge interval
Flasher starting with ON
Flasher starting with OFF
Single shot
- 7 time range, from 1 second to 100 hour
- 17.5 mm thin body design
- UL, C-UL recognized and CE certified

SPECIFICATION :

Operating voltage	AC/DC(V): 12~240
Allowable operating voltage range	90~110% of rated operating voltage
Rated frequency	50 / 60 Hz
Contact rating	250VAC 8A (resistive load)
Reset time	MAX 0.1s
Power consumption	Approx. 1.9VA
Life	Mechanical: 5,000,000 times Electrical: 100,000 times
Ambient temperature	-10 ~ +50°C
Ambient humidity	MAX 85%RH
Weight	Approximatly 62g

TYPE SELECTION :

Type	H3D-M
Time range	1s / 10s / 100s / 10m / 100m / 10h / 100h
Output contact	1C
Output mode	7 Mode

CONNECTION :

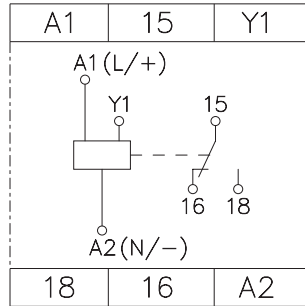

TIMING CHART :

Mode A: On-delay,

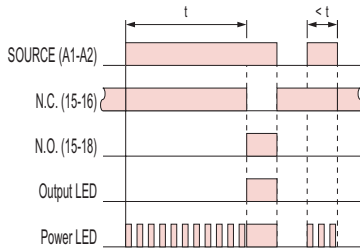

Mode B: Flasher starting with OFF,

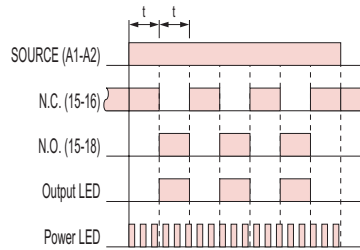

Mode B2: Flasher starting with ON,

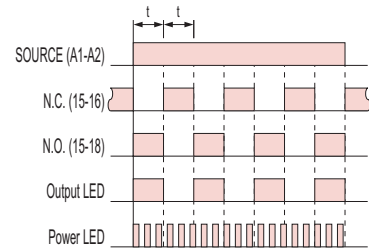

Mode D: Control contact OFF-delay,

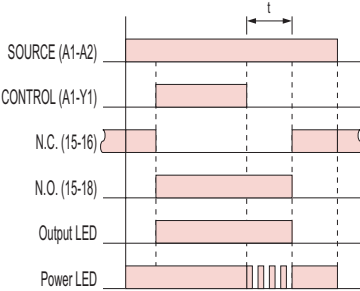

Mode D1: Trailing edge interval,

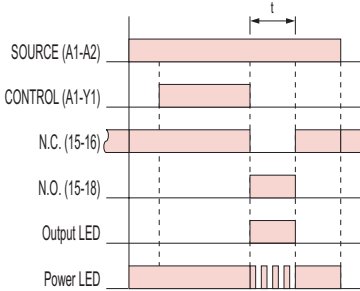

Mode E: Interval,

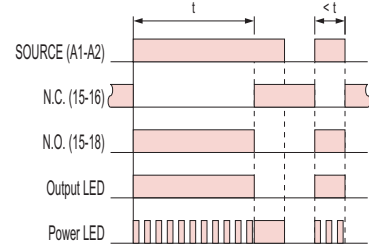

DIMENSIONS : (mm)

Mode J1: Single shot,

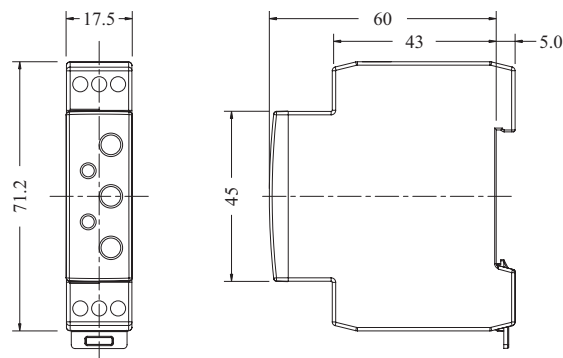
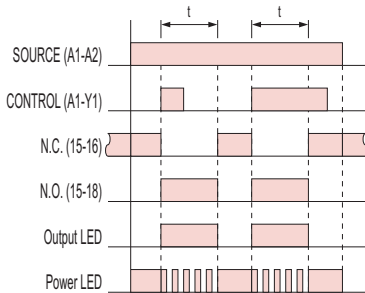

ANLY ELECTRONICS CO., LTD.

<http://www.anly.com.tw>

TAIWAN MAIN OFFICE : ANLY ELECTRONICS CO., LTD.

No. 19, Lane 202, Fushou St., Shinjuang City, Taipei, Taiwan 242
TEL: +886-2-2996-3202 FAX: +886-2-2996-2017

MALAYSIA BRANCH : JUSTY ELECTRONICS (M) SDN, BHD.

No. 1, Jalan 6/89B, Kawasan Perindustrian Trisegi, Batu 3 1/2 Off Jalan Sungei Besi, 57100 Kuala Lumpur, Malaysia
TEL: +60-3-7983-5758 FAX: +60-3-7981-5052

HONG KONG BRANCH : ANLY ELECTRONICS (HK) LTD.

Flat K, 13/F, Edward Mansion, 141 Prince Edward Road W., Kowloon, Hong Kong
TEL: +852-2397-2505 FAX: +852-2397-6080

SHANGHAI BRANCH : ANLY TECHNOLOGY (WUXI) CO., LTD.

Room 13G, No.831, Xinzha Rd., Jingan District, Shanghai, China 200041
TEL: +86-21-6218-3300 FAX: +86-21-6217-5911

NO. H3DM-H-A